

THE ULTIMATE GUIDE FOR CONTEMPORARY BATHROOMS

A Q U A N T[®]

OCTOBER
2020
**SPECIAL
ISSUE**

Artisan Wash Basin Collection

Bathroom
Design Ideas:
Wash Basins
in Alternative
Materials are
Trending

**MATERIALS
IN FOCUS
MARBLE**

ONYX

CONCRETE

STAINLESS STEEL

WOOD





Our Story

In 2006, Aquant started providing more than just basic sanitary ware and bathroom fixtures in the Indian market by actively seeking out exclusive and innovative products.

We are headquartered in the bustling, vibrant & dynamic Design Capital: Mumbai. Being an Indian company, we understand your homes better.

By working with some of India's leading designers, we understand the latest trends. Our design-sense is exemplified by the consistent launching of globally trending Sanitaryware, Faucets & Showering Systems.

Our collection is comprised of contemporary products that exude luxury and combine exquisite style with state-of-the-art technology, unparalleled performance and the highest quality.



Alternative Materials

A commitment to innovation and excellence in design is the core of our business strategy. Keeping up with this commitment, we dedicate a lot of time and energy to researching new materials and the design and development of bathroom pieces that offer new possibilities to users.

When an idea is born, we begin a process of experimentation in which we play with colors, designs, and materials. By thinking about concepts from countless angles, an idea takes shape, making every washbasin a work of art.

We give you the opportunity to bring artisan craftsmanship to your space. Create a lasting impression in your bathrooms, powder rooms, and dining areas by adding washbasins in materials such as Marble, Onyx, Concrete, Wood, and Stainless Steel.



Artisan Craftsmanship

Our stone basins are produced in Bali, a spiritual destination with ancient traditions where sculpture has arguably been one of the most important forms of documenting the human experience throughout history.

At our artisanal workshops in Bali, the process of crafting each basin begins by straight-casting single blocks of natural marble or onyx. The resulting stone blocks are then hand-crafted by highly skilled artisans using primordial sculptural techniques to create truly unique wash basins, each with a distinct set of material characteristics.

Our trendiest new launch, Aquant Concrete Basins are made with the finest concrete and have an extremely high level of water tolerance and stain resistance. We have made concrete lighter and stronger, enabling us to create shapes with thin-lines and curves.

Our newly launched Inox Steel range of wash basins are made from high-quality 304-Grade Stainless Steel. The material provides the wash basins with rich colors and long-lasting shine.

Made by craftsmen using the same techniques used to make luxury yacht furniture, our Wood wash basins are made from a composite of water-proof Bamboo finished using high-quality resin.

Steel Wash Basins

Inox Round GG	05
Inox Rectangle GG	05
Inox Round RG	06
Inox Rectangle RG	06

Bamboo Wood Basins

Madera N°1	07
Madera N°2	07

Cement Wash Basins

Beige Concrete	08
Grey Concrete	08

Pedestal Wash Basins

Iris	12
Caves Snow	13
Caves Noir	14
Caves Crema	16
Caves Crema with Taphole	16
Keyon Snow	17
Keyon Noir	18
Keyon Crema	18
Ego Gold	20
Ego Crema	20
Centaur	22
Venice	22
Onyx Mirror	22
Nirvana	24
Sophia	24
Zeus	25
Asura	26
Thumbu	26
Konig	27
Song-Blu	28
Balinese Teak Wood Base	28

Counter-Top Wash Basins

Crypton Snow	32
Crypton Noir	32
Crypton Emperador	33
Crypton Bianca	34
Crypton Gold	34

Aura Crema	35
Aura Emperador	35
Aura Snow	36
Aura Noir	36
Stella Bianca	37
Stella Snow	37
Stella Gold	38
Stella Carrara	38
Elte Emperador	39
Elte Noir	40
Elte Biaca	40
Vector Bianca	41
Vector Emperador	42
Vector Noir	42
Vector Gold	42
Vector Snow	42
Freya Carrara	44
Freya Gold	44
Circa Bianca	45
Circa Emperador	46
Circa Noir	46
Circa Snow	46
Circa Moon/Circa Moon-S	46
Duro	47
Duro Oda	47
Carino	48
Carino L	48
Cleo	49
Chloé	50
Doria	50
Cora	51
Crown	51
Solitaire	52
Teratai	52
Zenith Carrara	53
Halle Crema	53
Jade	54
Ellisi	54
Rio	56

Marble Components

Pop-up Marble Waste Coupling	57
------------------------------	----

Technical Specifications

Pedestal Wash Basins	58
----------------------	----

ONYX



Honey Onyx (Iran)

Honey Onyx imported from Iran offers a radiant and luxurious dimension to our stone basin assortment. Wash Basins made of Honey Onyx are characterized by warmth and incredible depth of color. This stone has a layered patterning that is translucent, luminous and very hard. This material can be backlit to create a dramatic effect.



Bianco Onyx (Iran)

This gorgeous White Onyx which is mined in Tuscany, Italy is one of the most luminescent available and is highly translucent. It is the rarest and most expensive natural material in our collection. Made with a beautiful onyx with a cloudy, contemplative mood, a Bianco Onyx Wash Basin offers its viewer enchanting pastel colors to calm the senses.

MARBLE



Statuario Marble (Italy)

As global trends have moved towards white/grey colored natural stones, Statuario Marble is our latest addition. Quarried in the Apuan Alps of Italy, Statuario Marble is an exclusive stone with a pure white background and dramatic, gorgeous grey veining in a striking pattern.



Carrara Marble (Italy)

Quarried in the city of Carrara located in the north of Tuscany, Italy, Carrara Marble is popular for its use in sculpture since ancient times. Found in different hues of white and gray colors, washbasins in Carrara marble are sure to add a luxe statement in your bathrooms and powder rooms.

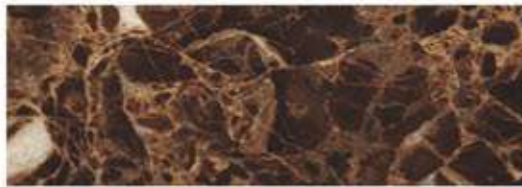

Dark Emperador Marble (Spain)

This marble is extracted in the region of Murcia, in the south-east of Spain and has a dark to medium brown color with cobweb-like patterns of golden intersecting veins. These veins create a subtle, three-dimensional texture which gives wash basins made from Dark Emperador marble an intriguing depth in their appearance.



Nero Marquina Marble (Spain)

This stunning marble is a high-quality black marble extracted from the region of Markina in the north of Spain. Thanks to the contrast between its brilliant and intense black color and the luminosity of its white veins, wash basins made from Nero Marquina marble are absolutely marvelous.



Cream Travertine Marble (Indonesia)

This beige/cream marble is the most stable natural stone material that we use for our range. Mined near Bali in Indonesia, the softness of the beige symbolizes tranquility, which is the essence of our stone products. Due to the material's economic price point, wash basins made of Travertine Marble are perfect for projects with budget constraints.

STAINLESS STEEL



Matt Rose Gold

With the trend for special finishes currently dominating bathroom design, Rose Gold is by far our best-loved finish. Aquant's unique Matt Rose Gold tone adds just the right amount of depth and luxury to any space.



Graphite Grey

Graphite Grey is a sophisticated and modern option which offers a great contrast to natural tiles and lighter hues. Many designers and passionate homeowners have shown great interest in playing with the juxtaposition of this finish.

CONCRETE



Beige Concrete

A perfect addition to timeless bathroom & powder room designs, Beige Concrete has an earthy tone which complements rustic design themes.



Grey Concrete

Grey Concrete complements the current design thinking in the bathroom and effortlessly matches any contemporary design theme or material palette.

OTHER MATERIALS



Bamboo Wood

Made by craftsmen using the same techniques used to make luxury yacht furniture, our Wood wash basins are made from a composite of water-proof Bamboo finished using high-quality resin.



River Stone

Riverstone is by far the strongest material in our portfolio. Since Riverstone washbasins are hand-carved from naturally occurring stones, each basin has a unique shape and size. The preferred choice for projects with a natural rustic theme.



Available in two stunning finishes: Graphite Grey & Matt Rose Gold, our newly launched Inox Steel range of wash basins are made from high-quality 304-Grade Stainless Steel. The material provides the wash basins with rich colors and long-lasting shine.

The understated elegance of the material and the visual brilliance of our designs characterized by slim lines make our Stainless Steel basins strikingly beautiful additions to your decor.



Inox Round GG

code
7003 GG

size
400 x 150 mm

available in
Graphite Grey ■

Inox Rectangle GG

code
7004 GG

size
525 x 325 x 150 mm

available in
Graphite Grey ■

Inox Round RG

code
7003 RG

size
400 x 150 mm

available in
Matt Rose Gold ■

Inox Rectangle RG

code
7004 RG

size
525 x 325 x 150 mm

available in
Matt Rose Gold ■



code - 7001



code - 7505



code - 7002



code - 7506

Madera N°1

code
7001

size
420 x 140 mm

Madera N°2

code
7002

size
550 x 360 x 130 mm

Made by craftsmen using the same techniques used to make luxury yacht furniture, our Wood wash basins are made from a composite of water-proof Bamboo finished using high-quality resin. Since a wooden wash basin is a departure from the norm and may create doubts about the material's suitability for the task, this range comes with a 5-Year warranty.

Beige Concrete

code
7505

size
565 x 370 x 120 mm

Grey Concrete

code
7506

size
565 x 370 x 120 mm

Our trendiest new launch, Aquant Concrete Basins are made with the finest concrete and have an extremely high level of water tolerance and stain resistance. We have made concrete lighter and stronger, enabling us to create shapes with thin-lines and curves. Each basin is sealed with a very effective, deep penetrating sealing system to allow a real-world function.

Stone Pedestal Wash Basins



Available in 4 types of stones: Honey Onyx, Statuario Marble, Nero Marquina Marble, and Travertine Marble, stone pedestal basins can be accommodated even in tight spaces.

Sculpted works of art, these hand-made basins are created by master artisans to become the centrepieces of any powder room or dining area.



▲
Iris
code
9064
size
450 x 850 mm
available in
Carrara Marble (Italy) ■



▲ Caves Noir

code
9096

size
400 x 900 mm

available in
Nero Marquina Marble (Spain) ■

◀ Caves Snow

code
9097

size
400 x 900 mm

available in
Statuario Marble (Italy) ■



▲ Caves Crema

code
9060

size
400 x 900 mm

available in
Travertine Marble (Indonesia) ■

▲ Caves Crema with Taphole

code
9065

size
400 x 900 mm

available in
Travertine Marble (Indonesia) ■



Keyon Noir

code
9069

size
450 x 450 x 900 mm

available in
Nero Marquina Marble (Spain) ■



Keyon Crema

code
9067

size
450 x 450 x 900 mm

available in
Travertine Marble
(Indonesia) ■

Keyon Snow

code
9070

size
450 x 450 x 900 mm

available in
Statuario Marble
(Italy) ■





▲ Ego Gold

code
9068

size
450 x 900 mm

available in
Honey Onyx (Iran) 🇮🇷



▲ Ego Crema

code
9066

size
450 x 900 mm

available in
Travertine Marble (Indonesia) 🇮🇩



▲ Centaur

code
9025

size
400 x 400 x 900 mm

available in
Honey Onyx (Iran) 🇮🇷



▲ Venice

code
9024 + 9001

size
450 x 270 x 750 mm

available in
Honey Onyx (Iran) 🇮🇷



◀ Onyx Mirror

code
9099

size
600 x 450 mm

available in
Honey Onyx (Iran) 🇮🇷



Nirvana

code
9051

size
400 x 900 mm

available in
Travertine Marble (Indonesia) ■



Sophia

code
9055

size
430 x 1000 mm

available in
Travertine Marble (Indonesia) ■



▲ Asura

code
9054

size
450 x 450 x 900 mm

available in
Travertine Marble (Indonesia) ■



▲ Thumbu

code
9059

size
400 x 300 x 900 mm

available in
Travertine Marble (Indonesia) ■

◀ Zeus

code
9063

size
450 x 400 x 900 mm

available in
Travertine Marble (Indonesia) ■



▲ Song-Blu

code
9091

size
450 x 550 mm

available in
Travertine Marble (Indonesia) ■

▲ Balinese Teak Wood Base

code
9093

size
400-450 x 420 mm

available in
Balinese Teak Wood ■

◀ Konig

code
9057

size
480 x 1000 mm

available in
Travertine Marble (Indonesia) ■



Millions of years old, Marble is one of history's more elegant creations. We source our rare Marble from some of the world's finest quarries in countries such as Italy, Spain and Indonesia.

A natural stone block with unique characteristics is transformed to create a precious wash basin which becomes the focal point of your bathroom or powder room. Every washbasin in this collection is hand-made by highly skilled artisans from Bali, giving an exclusive and unrepeatable value to each piece.



Crypton Snow
code
9213
size
430 x 150 mm
available in
Statuario Marble
(Italy)



Crypton Noir
code
9211
size
430 x 150 mm
available in
Nero Marquina
Marble (Spain)



Crypton Emperador

code
9212

size
430 x 150 mm

available in
Dark Emperador Marble (Spain) ■



code - 9215



code - 9214

Crypton Bianca

code
9215

size
430 x 150 mm

available in
Bianco Onyx (Italy) ■

Crypton Gold

code
9214

size
430 x 150 mm

available in
Honey Onyx (Iran) ■



code - 9042



code - 9210



code - 9209



code - 9208

Aura Crema

code
9042
size
670 x 380 x 150 mm

available in
Travertine Marble (Indonesia) ■

Aura Emperador

code
9209
size
670 x 355 x 135 mm

available in
Dark Emperador Marble (Spain) ■

Aura Snow

code
9210
size
670 x 355 x 135 mm

available in
Statuario Marble (Italy) ■

Aura Noir

code
9208
size
670 x 355 x 135 mm

available in
Nero Marquina Marble (Spain) ■



Stella Bianca
code
9010 WO
size
700 x 390 x 130 mm
available in
Bianco Onyx
(Italy)



Stella Gold
code
9010 HO
size
700 x 390 x 130 mm
available in
Honey Onyx
(Iran)



Stella Snow
code
9207
size
700 x 390 x 130 mm
available in
Statuario Marble
(Italy)



Stella Carrara
code
9010 CW
size
700 x 390 x 130 mm
available in
Carrara Marble
(Italy)



Elte Emperador

code
9004

size
510 x 380 x 145 mm

available in
Dark Emperador Marble (Spain) ■



code - 9005



code - 9087

Elte Noir

code
9005

size
510 x 380 x 145 mm

available in
Nero Marquina Marble (Spain) ■

Elte Bianca

code
9087

size
510 x 380 x 145 mm

available in
Bianco Onyx (Italy) ■



Vector Bianca

code
9206
size
480 x 350 x 140 mm
available in
Bianco Onyx (Italy) ■



code - 9203



code - 9205

Vector Emperador

code
9203
size
480 x 350 x 140 mm
available in
Dark Emperador Marble (Spain) ■

Vector Gold

code
9205
size
480 x 350 x 140 mm
available in
Honey Onyx (Iran) ■



code - 9202



code - 9204

Vector Noir

code
9202
size
480 x 350 x 140 mm
available in
Nero Marquina Marble (Spain) ■

Vector Snow

code
9204
size
480 x 350 x 140 mm
available in
Statuario Marble (Italy) ■



Freya Carrara
code
9012
size
600 x 500 x 140 mm
available in
Carrara Marble
(Italy)



Freya Gold
code
9011
size
600 x 500 x 140 mm
available in
Honey Onyx
(Iran)



Circa Bianca

code
9018
size
420 x 150 mm
available in
Bianco Onyx (Italy) ■



code - 9003



code - 9002



code - 9201



code - 9001/9023

Circa Emperador

code
9003
size
420 x 150 mm
available in
Dark Emperador Marble (Spain) ■

Circa Noir

code
9002
size
420 x 150 mm
available in
Nero Marquina Marble (Spain) ■

Circa Snow

code
9201
size
420 x 140 mm
available in
Statuario Marble (Italy) ■

Circa Moon/Circa Moon-S

code	code
9001	9023
size	size
420 x 150 mm	350 x 130 mm
available in	available in
Honey Onyx (Iran) ■	



Duro
code
9044
size
500 x 350 x 130 mm
available in
Travertine Marble
(Indonesia)



Carino
code
9076
size
350 x 150 mm
available in
Travertine Marble
(Indonesia)



Duro Oda
code
9073
size
510 x 380 x 145 mm
available in
Travertine Marble
(Indonesia)



Carino L
code
9077
size
400 x 150 mm
available in
Travertine Marble
(Indonesia)



Cleo
code
9009
size
700 x 450 x 120 mm
available in
Honey Onyx (Iran) 🇮🇷



code - 9006



code - 9028

Chloé
code
9006
size
500 x 350 x 130 mm
available in
Honey Onyx (Iran) 🇮🇷

Doria
code
9028
size
500 x 400 x 150 mm
available in
Honey Onyx (Iran) 🇮🇷



Cora
code
9043
size
500 x 400 x 150 mm
available in
Travertine Marble
(Indonesia)



Solitaire
code
9035
size
400 x 190 x 140 mm
available in
Travertine Marble
(Indonesia)



Crown
code
9033
size
400 x 150 mm
available in
Travertine Marble
(Indonesia)



Teratai
code
9045
size
450 x 100 mm
available in
Travertine Marble
(Indonesia)



Zenith Carrara
code
9083
size
550 x 350 x 100 mm
available in
Travertine Marble
(Indonesia)



Jade
code
9038
size
600 x 400 x 150 mm
available in
Travertine Marble
(Indonesia)



Halle Crema
code
9072
size
500 x 380 x 135 mm
available in
Travertine Marble
(Indonesia)



Ellissi
code
9078
size
400 x 330 x 130 mm
available in
Travertine Marble
(Indonesia)



Rio
code
9031
size
500 x 150 mm*
available in
River Stone
Black or Greyish Finish ■



*Since each basin is hand carved from a unique river stone block, every piece has a variation in its shape, size & colour.



Pop-up Marble Waste Coupling

code
1023

size
32 mm x 12 cm

available in

- Bianco Onyx (Italy)
- Nero Marquina Marble (Spain)
- Carrara Marble (Italy)

- Travertine Marble (Indonesia)
- Dark Emperador Marble (Spain)

- Statuario Marble (Italy)
- Honey Onyx (Iran)

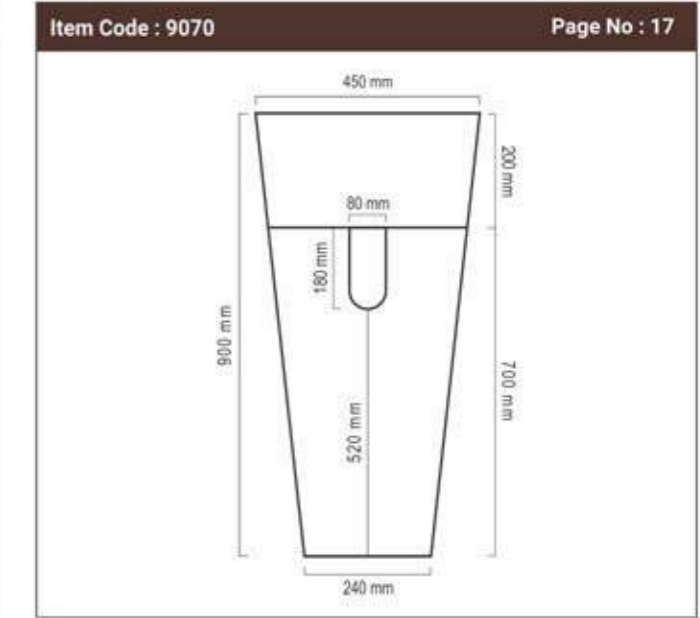
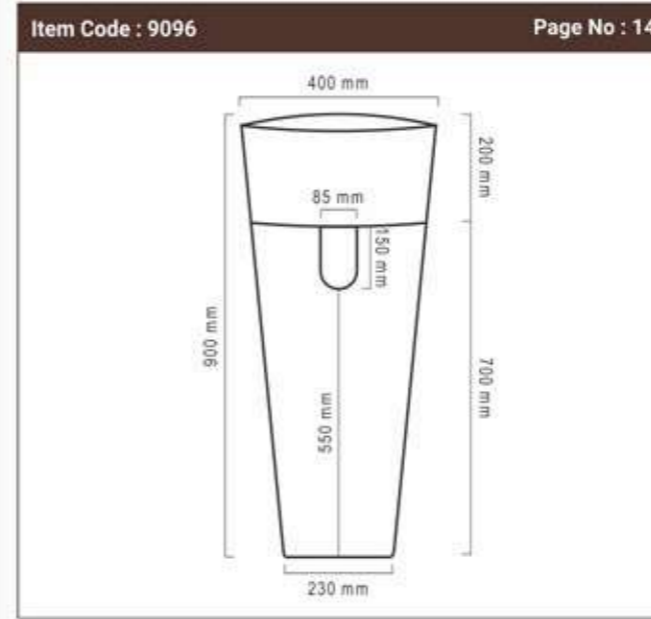
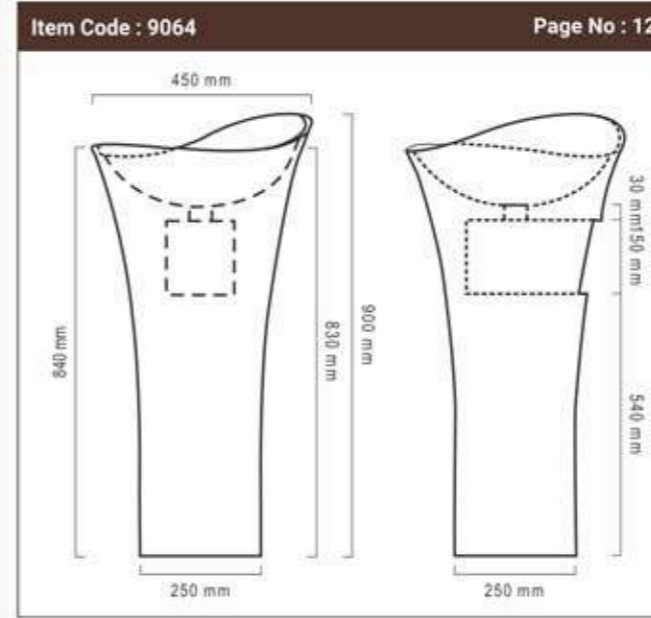

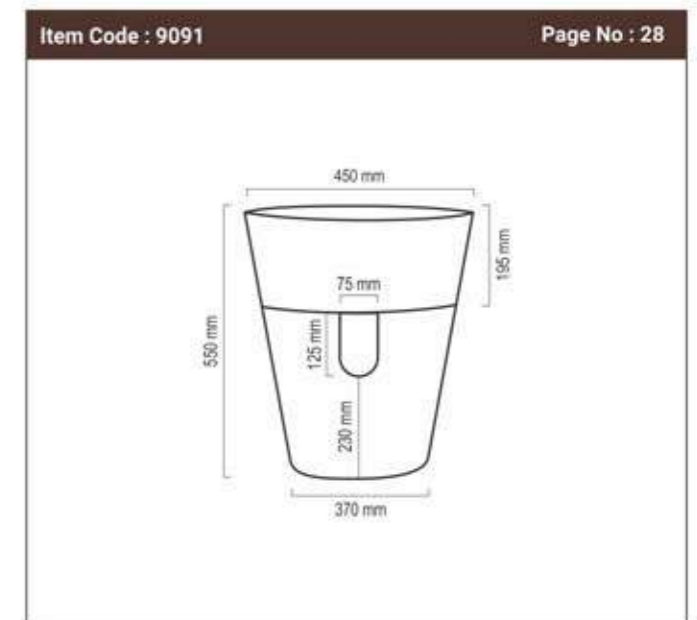
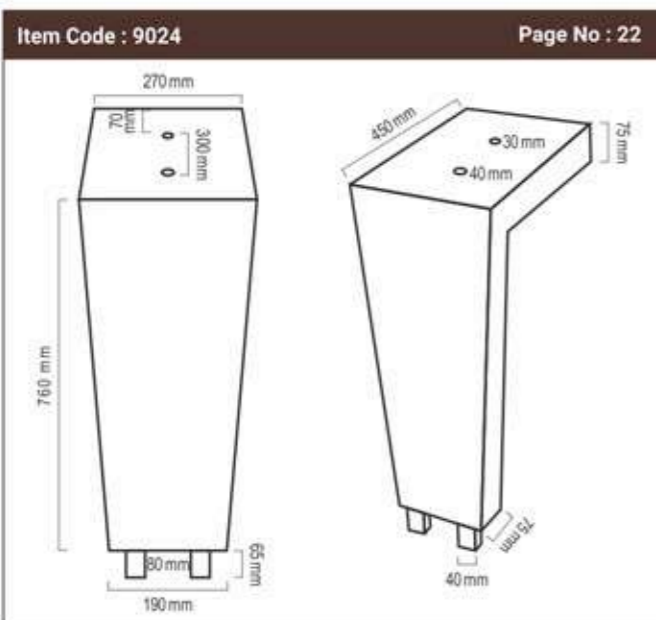
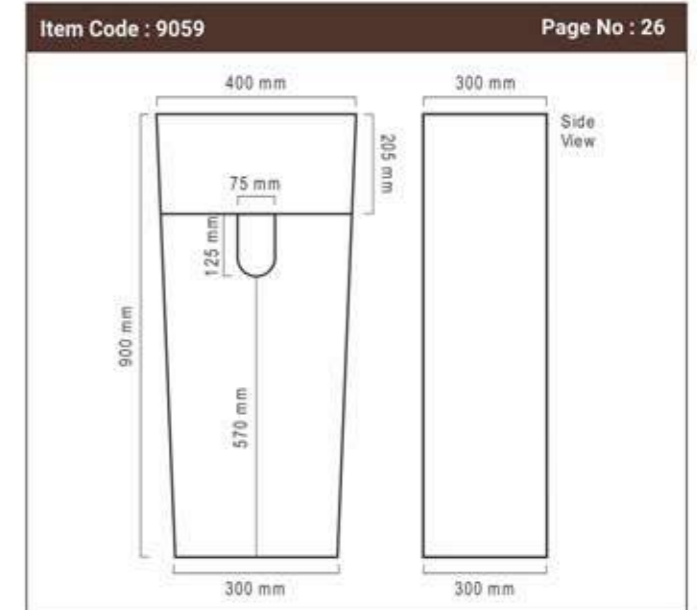
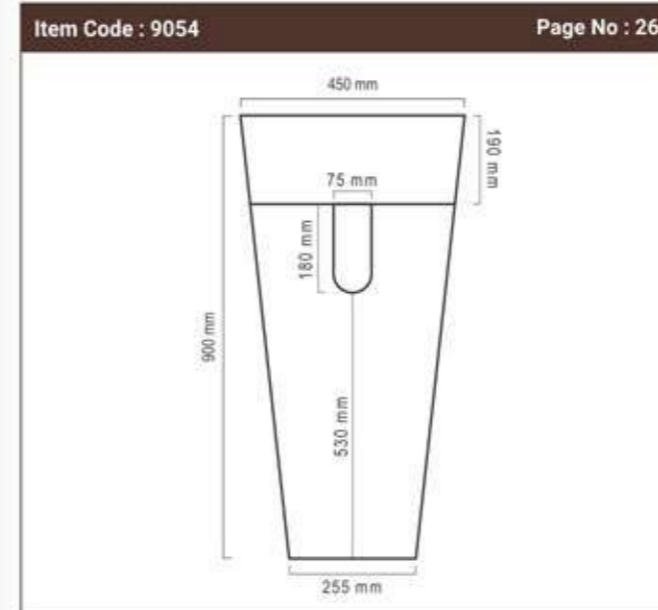
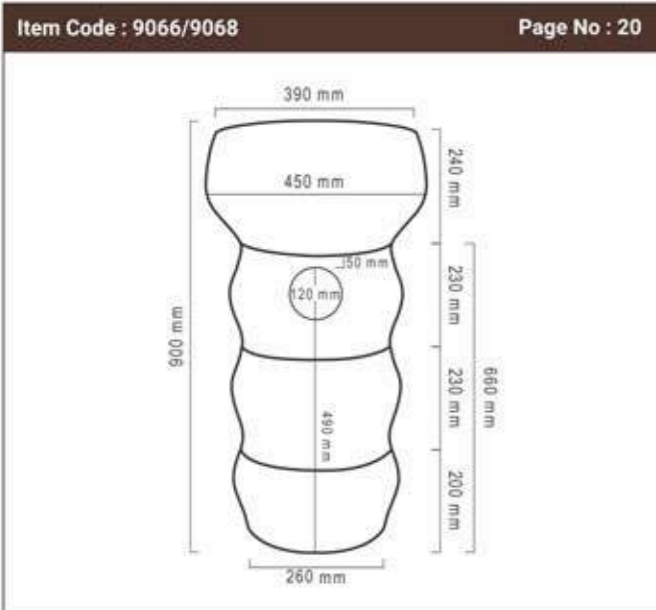
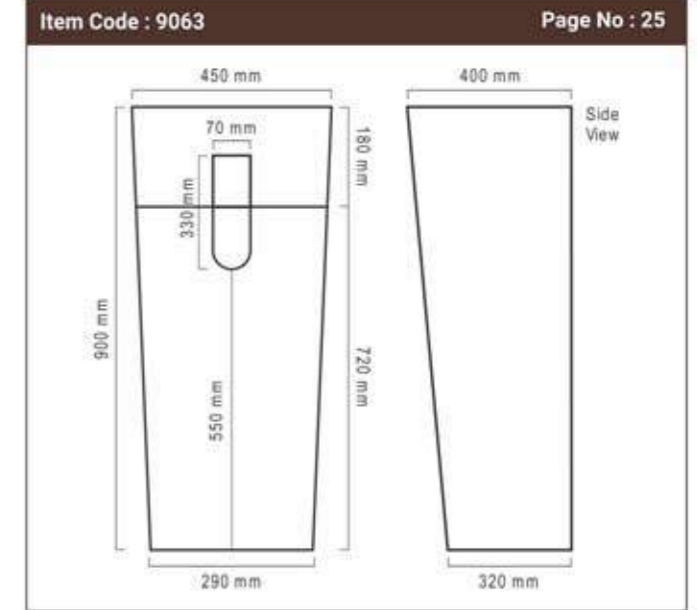
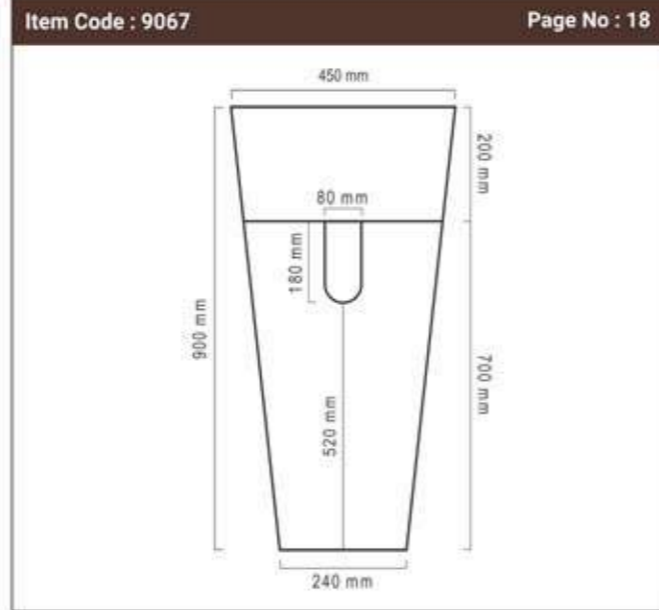
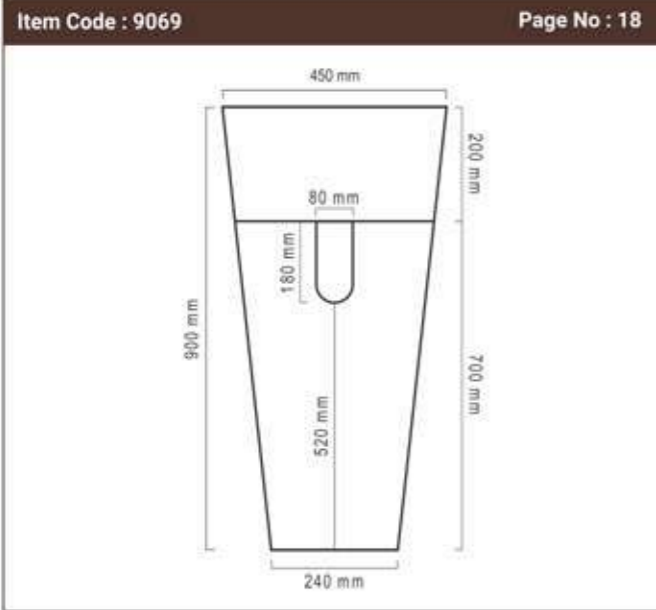

The various stones used have been chosen for their strong concentration of fossils and as they are purely natural product, there will also be the presence of different variations of veins, colors and shades, as well as micro cracks and small holes. This gives each piece the characteristic of being truly unique.

- Do not place the product outdoors or in direct exposure to sun light.
- The product can be cleaned with warm water, a mild soap and a clean soft cloth.
- It is not required to use any abrasive cleaning pads, wire wool or micro-fibre cloths to clean the product. Avoid a vigorous cleaning action.
- Abrasive or strong cleaning products containing ammonia, bleaches, alcohol, dyes, acids (hydrochloric, formic, phosphorus, chlorine or acetic) will be detrimental to the product finish.
- Do not use strong cleaners on Wash Basins.
- If using a spray cleaner, apply the cleaning agent onto the soft cloth, never directly spray onto the product as the cleaner may enter gaps and openings and cause damage.
- Residues of toiletries such as liquid soaps, shower gels, shampoos, hair dyes, perfumes, lipstick, after shave and nail varnish can also cause damage if not wiped up right away, this can allow the acids to react and eat away at the calcium carbonate in the stone, creating permanent markings.
- If a specialized cleaner is required, always follow the instructions provided on the cleaning product, this would include application and dosage.
- Always test the cleaning agent on an inconspicuous area before applying to the whole surface, do not allow the cleaner to remain on the product for a period of time.
- After cleaning, rinse thoroughly with clean water.
- Ensure that specialized cleaners are only applied to the specific area and do not come into contact with other materials that could be affected by it.
- We would not recommend the mixing of different cleaning agents.
- After cleaning, dry with a soft cloth.

Caring for Wood, Concrete, & Stainless-Steel Basins

- The product can be cleaned with warm water, a mild soap and a clean soft cloth.
- Do not place the product outdoors or in direct exposure to sun light.
- It is not required to use any abrasive cleaning pads, wire wool or micro-fibre cloths to clean the product. Avoid a vigorous cleaning action.
- Abrasive or strong cleaning products containing ammonia, bleaches, alcohol, dyes, acids (hydrochloric, formic, phosphorus, chlorine or acetic) will be detrimental to the product finish.
- Do not use strong cleaners on Wash Basins.
- If using a spray cleaner, apply the cleaning agent onto the soft cloth, never directly spray onto the product as the cleaner may enter gaps and openings and cause damage.
- Residues of toiletries such as liquid soaps, shower gels, shampoos, hair dyes, perfumes, lipstick, after shave and nail varnish can also cause damage, carefully clean these using the methods above.
- If a specialized cleaner is required, always follow the instructions provided on the cleaning product, this would include application and dosage.
- Always test the cleaning agent on an inconspicuous area before applying to the whole surface, do not allow the cleaner to remain on the product for a period of time.
- Stainless-Steel may discolor if left in contact with salts or acids for extended periods.
- After cleaning, rinse thoroughly with clean water.
- We would not recommend the mixing of different cleaning agents.
- After cleaning, dry with a soft cloth.

AQUANT's products used in normal residential and non-residential commercial settings are warranted to be free of defects in the material and workmanship for the period of time set forth in the warranty coverage chart as detailed below, commencing from date of sale of AQUANT's products to the original purchaser ("warranty period"):

Category	Residential Use	Non-Residential Commercial Use
Marble & Onyx Wash Basins	5 Years	2 Years
Wooden Wash Basins	5 Years	2 Years
Stainless-Steel Basins	2 Years	1 Year
Concrete Basins	2 Years	1 Year

A Q U A N T

CONTEMPORARY BATHROOMS

www.aquantindia.com